



IPC SHOOTING RULES AND REGULATIONS

MARCH 2010 (V.1.1)

TABLE OF CONTENTS

1	IPC SHOOTING	5
1.1	Name	5
1.2	Governance	5
1.3	Objectives	5
1.4	Code of Ethics	6
1.5	Language	6
1.6	IPC Shooting recognized competitions	6
1.7	IPC Shooting Technical Committee (STC)	6
1.8	IPC Shooting Forum (SF)	6
1.9	Rights and Obligations of IPC Members	6
1.10	Printing of Rules and Regulations	7
2	IPC SHOOTING GENERAL RULES	8
2.1	Events and Programme of Events	8
2.2	Athletes' Eligibility	9
2.3	Start Number	9
2.4	Equipment	10
2.5	Athlete's Assistants for classes SH1/SH2	16
2.6	Protests and Appeals	17
2.7	Disqualification	17
2.8	Protocol	18
CHAPTER 3		19
3	RIFLE RULES	19
3.1	Rifle Events and shooting times	19
3.2	Tie breaking	20
CHAPTER 4		21
4	PISTOL RULES	21
4.1	Pistol Events and shooting times	21
4.2	Loading device (safety)	21
4.3	Shooting position	21
CHAPTER 5		22
5	SHOOTING FOR VISUALLY IMPAIRED ATHLETES	22
6	FALLING TARGETS RULES	23

6.1	Competition Format	23
6.2	Competition Commands	23
CHAPTER 7	25
7 TEAM COMPETITION	25
7.1	Team Competition	25
CHAPTER 8	26
8 REGULATIONS	26
8.1	Competition Management	26
8.2	Officials	27
8.3	Minimum Qualifying Standards (MQS)	28
8.4	Competitions and Qualifications	30
8.5	Process for Approved Competitions	30
8.6	Process for Sanctioned Competitions	31
8.7	Results	31
8.8	Rankings	32
8.9	World and Regional Records	33
CHAPTER 9	34
9 EDUCATION	34
9.1	IPC Shooting Technical Officials	34
9.2	IPC Shooting Technical Officials Levels	34
CHAPTER 10	36
10 PRIOR COMPETITION PROCESSES	36
10.1	Equipment Control	36
10.2	International Classification	36
10.3	Technical Meeting	36

CHAPTER 1

1 IPC SHOOTING

1.1 Name

The name shall be International Paralympic Committee Shooting, hereinafter known as IPC Shooting. IPC Shooting shall incorporate, with amendments, the relevant Rules and Laws of the International Shooting Sport Federation (ISSF).

Note: Any reference in IPC Shooting rulebook to ISSF rules and regulations refers to its newest edition (including appendixes)..

1.2 Governance

The International Paralympic Committee (IPC) is the global governing body for the Paralympic Movement and IPC Shooting is a brand of the IPC. For further details refer to IPC Handbook section 1.

The ISSF sport technical rules are fully integrated into the official IPC Shooting rulebook and shall be enforced in all cases except where they are modified by these rules of IPC Shooting. The ISSF rules are re-enforced and not inserted or restated here and the rules in this rulebook must be read in conjunction with the ISSF rules.

1.3 Objectives

The objectives of IPC Shooting are:

- 1.3.1 To promote and encourage the development of IPC Shooting in all possible manifestations throughout the world,
- 1.3.2 To promote drug free sport,
- 1.3.3 To promote and encourage the development of international relations,
- 1.3.4 To adopt necessary uniform rules, regulations and classifications, to hold competitions in Shooting,
- 1.3.5 To organize World Championships and other IPC Shooting competitions,
- 1.3.6 To grant approval/sanctioning of competitions,
- 1.3.7 To carry out such other activities as may be desirable to promote the sport

1.4 Code of Ethics

The IPC Code of Ethics in IPC Handbook – Section 2 applies.

1.5 Language

- 1.5.1 The official language of IPC Shooting shall be English. Any other language may be used in correspondence or debate providing that adequate translation is provided. In cases of doubt, the English language shall prevail.

1.6 IPC Shooting recognized competitions

IPC Shooting Recognized Competitions include:

- 1.6.1 IPC Competitions (Paralympic Games, IPC Shooting World Championships, IPC Shooting Regional Championships)
- 1.6.2 IPC Sanctioned Competitions (World Cup)
- 1.6.3 IPC Shooting Approved Competitions (International shooting competitions endorsed by the NPC).
- 1.6.4 IPC Shooting competition levels are as follows:

Level 4: Paralympic Games

Level 3: World and Regional Championships

Level 2: World Cups

Level 1: Approved Competitions

1.7 IPC Shooting Technical Committee (STC)

The technical advisory body of IPC Shooting is the Shooting Technical Committee. The IPC Handbook – Section 2 - Chapter 2.7 - IPC Sport Technical Committee (STC) Bylaws apply.

1.8 IPC Shooting Forum (SF)

The IPC Shooting Forum comprises mandated technical representatives from the NPCs widely practicing shooting to meet and discuss the development of the sport. The list of NPCs widely practicing shooting will contain the NPCs that participated in IPC Shooting recognized competition(s) within the last 2 years.

1.9 Rights and Obligations of IPC Members

This section of the rule book is based on the IPC Handbook – Section 1 - Chapter 2.1 – Rights and Obligations of IPC Membership.

1.10 Printing of Rules and Regulations

1.10.1 All rules of IPC Shooting are solely for the benefit of NPCs and may be reprinted or translated by any NPC under its responsibility, with the understanding that in all cases where the translated text differs in interpretation, the English version shall be accepted.

1.10.2 Any other organisations desiring to publish these Rules shall obtain the permission of IPC Shooting.

CHAPTER 2

2 IPC SHOOTING GENERAL RULES

2.1 Events and Programme of Events

2.1.1 IPC Shooting will select events for each competition from the following list of events:

Event	Discipline	Gender	Class
R1	10m Air rifle standing	Men	SH1
R2	10m Air rifle standing	Women	SH1
R3	10m Air rifle prone	Mixed	SH1
R4	10m Air rifle standing	Mixed	SH2
R5	10m Air rifle prone	Mixed	SH2
R6	50m Rifle prone	Mixed	SH1
R7	50m Free Rifle 3x40	Men	SH1
R8	50m Sport Rifle 3x20	Women	SH1
R9	50m Rifle prone	Mixed	SH2
FTR1	Falling Targets	Mixed	SH1
FTR2	Falling Targets	Mixed	SH2
P1	10m Air pistol	Men	SH1
P2	10m Air pistol	Women	SH1
P3	25m Sport pistol	Mixed	SH1
P4	50m Free pistol	Mixed	SH1
P5	Air Pistol Standard	Mixed	SH1
FTP	Falling Targets	Mixed	SH1

2.1.2 The list of events for a competition may change until the final entry verification is closed.

2.1.3 The programme of event shall not be modified.

2.1.4 Only IPC Shooting is authorized to grant exceptions on the programme.

2.1.5 A 4-year-cycle for Championships will be adopted as follows:

- Year 1: Regional Championships (except if included in Regional Games)
- Year 2: World Championships
- Year 3: Regional Championships (except if included in Regional Games)
- Year 4: Paralympic Games

2.2 Athletes' Eligibility

2.2.1 All competitors must adhere to the IPC Nationality Policy: IPC Handbook – Section 2 - Chapter 3.1 - IPC Athlete Nationality.

2.2.2 At IPC Competitions, and sanctioned competitions all competitors shall be licensed by IPC Shooting in accordance with the IPC Athlete Licensing Policies.

2.2.3 At IPC Competitions, and sanctioned competitions all athletes shall have international classification. Athletes with N status require international classification prior to competition start. IPC Shooting determines the allocation of a shooters class and status. Reference to all classification procedures and requirements are contained in the IPC Shooting Classification Manual.

2.2.4 If the Athlete's License Card is lost a fee of 25€ will be charged.

2.2.5 SH2 eligibility in small bore events.

For safety reasons, the shooter has to prove his/her skill before participating in this event. This has to be done by obtaining the zonal qualification score for air rifle prone or standing, in a World Cup, Regional or World Championships or Paralympic Games.

2.3 Start Number

2.3.1 The start numbers are produced and distributed by the Local Organizing Committee.

2.3.2 In case that the start number is available but not worn the athlete may not commence/continue.

2.3.3 The start number must be assigned to specific athletes and appear on all competition lists and timetables.

2.3.4 The start number size and design must be as shown on the design in Appendix 1

2.4 Equipment

2.4.1 General

All equipment specific to IPC Shooting must conform to the following IPC Shooting standards.

2.4.2 The equipment used must be inspected and passed before the start of the competition as per the ISSF and IPC Shooting rules. A checklist as described in Appendix 2 shall be used as a record of the checking process.

2.4.3 Shooting Chairs

2.4.3.1 For definition purposes, wheelchairs, stools, chairs and seats will be referred to as 'shooting chairs'.

2.4.3.2 The height of these standard shooting chairs can vary between 35 and 45 cm.

2.4.3.3 Shooting chairs with a height above 45 cm are considered as high shooting chairs. For these chairs a conversion table indicates the maximum height of the chair in relation to the length from the floor to the top of the knee. The conversion table is based on the following calculation:

$$\text{Top of knee} \times 1,12 = \text{max height of seat}$$

2.4.3.4 The measurement is done with shooting equipment, shoes, gear and measured in sitting position.

2.4.3.5 All shooting chairs will be checked with the shooter in the shooting position during the equipment control and will be subject to spot checks on the shooting line before, during or immediately after the competition.

2.4.3.6 No part of the backrest of any shooting chair will be permitted to exceed the maximum height laid down in these rules, including and especially the vertical side posts of the backrest. (see picture)

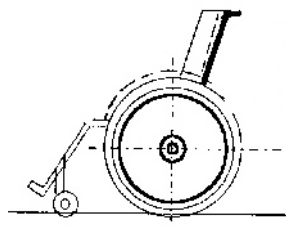

Handles and side posts may not exceed height of backrest

2.4.3.7 No part of the backrest may be higher than the maximum height allowed by the shooter's classification.

2.4.3.8 The maximum slack (stretch) of the fabric of the backrest, that is the distance from the front of the vertical side posts of the backrest to the deepest part of the backrest, shall not exceed 8 cm. This is to be measured with the shooter in the chair in the shooting position. (see picture)

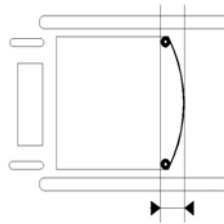

Slack < 8cm

2.4.3.9 For sitting shooters in class SH1A and SH2A who are not shooting from a wheelchair must use a high shooting chair suited to his/her height.

- The maximum surface of the seat is 45x45 cm
- The sitting angle is unlimited.
- The angle of the surface of the seat of the shooting chair is allowed up to 5 degrees from horizontal.
- The chair may be upholstered with material compressible up to a maximum of 5 cm.
- The shooter must be able to remove his/her feet off the floor, without losing balance and without moving the upper body.

- 2.4.3.10 Shooters and their equipment must be within the designated size of their firing point.
- 2.4.3.11 The centerline of the barrel in case of sitting competitors must not exceed more than 150 cm, measured from the ground or floor. IPC Shooting can decide, to allow different heights, due to certain circumstances.
- 2.4.3.12 The sitting angle and backrest angle is free.
- 2.4.3.13 For class SH1B & SH2B shooters a minimum of 60% of the total back-length of the shooter need to be above the backrest. The length of the spine is measured in vertical position from the surface on which the shooter is sitting, along the contour of the spine to the middle of vertebra C7 (vertebra prominence). The measurement will be done during functional classification without shooting gear.

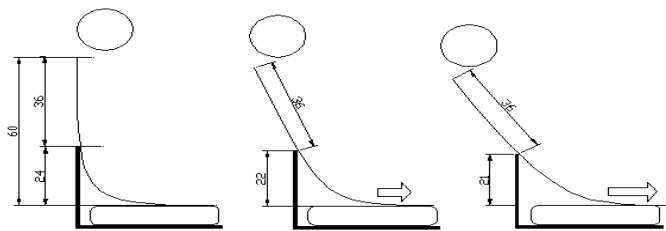

- 2.4.3.14 For class SH1C & SH2C shooters the length measured from C7 until 10 cm under the armpits (axilla), at the rifle supporting side for rifle shooters and the side of the shooting arm for pistol shooters, needs to be free above the backrest. (see picture)

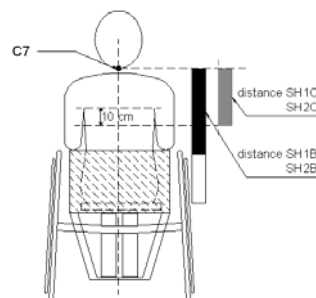

- 2.4.3.15 The minimum length of back above the backrest will be marked on the ID card. (see picture)
- 2.4.3.16 The minimum length of back above the backrest will be marked on the shooting jacket (as a reference only) in the center of the back and the mark must be visible at all times.
- 2.4.3.17 For SH1A and SH2A shooters, a back-support of any height may be fitted to the shooting chair in

such a way that competitors may take a rest against it between shots. However there must be clearly no contact between shooter and back-support when firing.

2.4.3.18 Sitting competitors in class SH1A and SH2A may choose to stand. If so they must stand free of any artificial support with the exception of medically certified normal prosthesis/ orthosis.

2.4.3.19 A shooting chair will be supplied by the competitor.

2.4.3.20 Strapping to wheelchairs: it is permitted to have 1 below knee strap to the chair and the legs may be strapped together once above the knees but not to the chair. It is not allowed to hold or touch straps to gain stability. In the case of double above-knee amputees a strap across the stumps and strapped to the chair is permitted. Straps must not exceed 5 cm in width.

2.4.3.21 All parts of the shooters equipment or body, which make contact with the floor or ground, must be behind the firing line.

2.4.4 Shooting Tables

2.4.4.1 Shooting tables for sitting classes may be attached to the shooting chair or may be free standing. A small upstanding edge to prevent small items from falling may be fitted but in no way shall it be used for additional stability or support of the shooter.

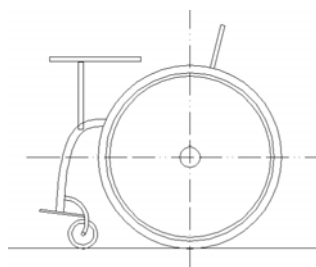
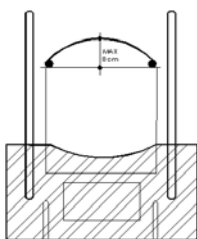

- 2.4.4.2 The shooting table must be horizontal or at the same angle as the floor, measured at the center of the table. (A variation of +/-5 degrees is allowed)
- 2.4.4.3 In rifle shooting the table or board may be upholstered with compressible material of a maximum thickness of 2 cm. Other material on the table must be of uniform thickness for both elbows. It is not permitted to make a hollow in the table or board or in the upholstered material.
- 2.4.4.4 If required because of uneven arm length or similar problem, a compensating block may be used, but this fact must be authorized by the functional classification panel and marked on the classification card.
- 2.4.4.5 The maximum surface for support of the elbow in kneeling position is 10 cm in diameter.
- 2.4.4.6 If a large table is used in the kneeling position, a removable board with a diameter of 10 cm and a thickness of at least 20 mm must be attached to this table fixed at the full board. (see picture)

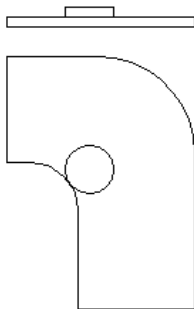

- 2.4.4.7 The table, if fitted, must not be used to gain support or stability for the body in any way, except for prone position. A separate board or table may be allowed for the shooting stand.

2.4.5 Shooting Jackets

- 2.4.5.1 The maximum length of the shooting jacket may not be longer than down to the lap in front and down to the top of the cushion in back, in case of sitting competitors. The length of the jacket will be measured in standing shooting position.

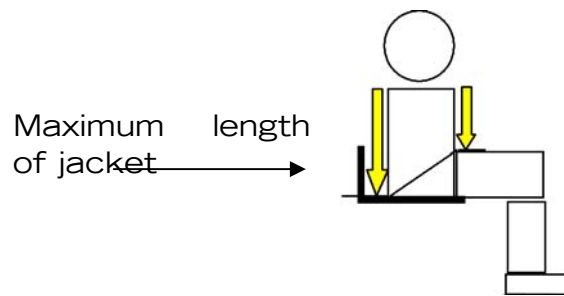

2.4.5.2 Maximum length of the jacket.

For SH1A, SH2A and SH3 shooters an ordinary jacket as prescribed by ISSF is allowed in case they shoot from a high stool or free standing. No competitors are allowed to sit on their shooting jackets during competition. When shooting from a wheelchair, rule 2.4.5.1 applies.

2.4.5.3 The same shooting jacket may be used in all shooting positions. Only one shooting jacket may be approved by equipment control for each shooter for all rifle events in one competition.

2.4.5.4 An exception to the above rule is made for SH1/SH2 athletes in the following cases:

- shooting the prone position lying on the floor or table
- shooting the kneeling position from a standard shooting chair
- in event R6 (50 m prone SH1), R7 Free Rifle), R8 (Standard Rifle) and/or R9 (50 mtr prone SH2)
- shooting Air Rifle prone from a standard shooting chair.

In these cases it is allowed to use an ISSF regulated jacket in this position only.

2.4.6 Shooting Trousers

- 2.4.6.1 Shooting trousers are prohibited for sitting competitors.
- 2.4.6.2 For SHA1 shooters shooting trousers as prescribed by ISSF is allowed in case they shoot from a high stool or free standing.
- 2.4.6.3 For definition of the shooting trousers, refer to ISSF rules.

2.4.7 Orthopaedic boots

- 2.4.7.1 Orthopaedic boots are individually prescribed and fashioned footwear used all day in daily life to enable the individual's medical condition. It must be checked and recorded at classification if this footwear may be used in competition.

Note: Specifications for class SH1 and class SH2 are available on the IPC Shooting Classification rules and regulations (2005-2008) and appendixes A and B of the Classification rules and regulations document.

2.5 Athlete's Assistants for classes SH1/SH2

2.5.1 Athlete's Assistants for classes SH1 and SH2

- 2.5.1.1 Competitors may be allowed to have a target-changer or a loading-assistant if necessary.
- 2.5.1.2 The decision to be allowed a loading-assistant can only be made by the classification panel and will be marked on the classification form and the ID card.
- 2.5.1.3 The loading-assistant must not speak or give signals during the match. He/she may only load the rifle and/or adjust the sights at the request of the shooter.
- 2.5.1.4 The target-changer must not speak or give signals during the match. He/she may only change targets.
- 2.5.1.5 The target-changer and/or loading-assistant must be at least 1 m behind the competitor between shots. Exceptions can be made at the discretion of the Jury.
- 2.5.1.6 Coaches are permitted to approach the line on request of the shooter if permitted by the range official.

2.6 Protests and Appeals

- 2.6.1 Violation of the rules will be handled as per I.S.S.F / IPC Shooting rules.
- 2.6.2 All protests, appeals inclusive, regarding technical matters must be handled as per I.S.S.F. rules.
- 2.6.3 The protest fee must be delivered to the Organising Committee. The appropriate fee must accompany appeals. If the protest is upheld, the Organizing Committee must return the protest fee. If the protest is denied the protest fee will be retained by the IPC Shooting.
- 2.6.4 The decision of the Jury of Appeal is final.

2.7 Disqualification

- 2.7.1 An athlete, team official, team member or any other who:
 - contravenes the spirit of fair-play offends manifestly members of any committee, officials or referees in the course of his/her official duties
 - behaves himself/herself in a manner which discredits IPC Shooting, IPC, any International Federation or the Organizers of a competition may be penalized, according ISSF and IPC rules.

2.7.2 Situations that are not covered by the rulebook will be examined under a “case by case” base by the IPC Shooting.

2.8 Protocol

2.8.1 Medals: Gold, Silver and Bronze medals shall be awarded to the first three places in individual events.

2.8.2 In team events, medals shall be awarded to all shooters who shot in the final (3 gold, 3 silver, 3 bronze).

2.8.3 In Regional Championships, medals shall be awarded to the first 3 finalists of the region in the final.

2.8.4 In Open Regional Championships, medals shall be awarded to the first 3 finalists of the open results list after the final.

2.8.5 The national flags of the countries of the competitors placed 1st, 2nd and 3rd shall be raised and the national anthem (abbreviated version) of the country of the champion shall be played.

- o The flags shall be hung in alphabetical order of the Host Country/Territory language from top to bottom.

CHAPTER 3

3 RIFLE RULES

3.1 Rifle Events and shooting times

3.1.1 All shooting times are according to ISSF and IPC rules.

3.1.2 World Championships, Regional Championships and World Cups can comprise out of the following rifle events:

Event	Discipline	Gender	Class	Shots	Time
R1	10m Air rifle standing	Men	SH1	60	1:45
R2	10m Air rifle standing	Women	SH1	40	1:15
R3	10m Air rifle prone	Mixed	SH1	60	1:30
R4	10m Air rifle standing	Mixed	SH2	60	1:45
R5	10m Air rifle prone	Mixed	SH2	60	1:30
R6	50m Rifle prone	Mixed	SH1	60	1:30
R7	50m Free Rifle .22	Men	SH1	40 prone 40 standing 40 kneeling	1:00 1:30 1:15
R8	50m Sport Rifle .22	Women	SH1	20 prone 20 standing 20 kneeling	2:30
R9	50m Rifle prone	Mixed	SH2	60	1:30

3.1.3 For Paralympic Games the times are as follows:

Event	Discipline	Gender	Class	Shots	Time
R1	10m Air rifle standing	Men	SH1	60	1:45
R2	10m Air rifle standing	Women	SH1	40	1:15
R3	10m Air rifle prone	Mixed	SH1	60	1:30
R4	10m Air rifle standing	Mixed	SH2	60	1:45
R5	10m Air rifle prone	Mixed	SH2	60	1:30
R6	50m Rifle prone	Mixed	SH1	60	1:30
R7	50m Free Rifle .22	Men	SH1	40 prone 40 standing 40 kneeling	1:00 1:30 1:15
R8	50m Sport Rifle .22	Women	SH1	20 prone 20 standing 20 kneeling	2:30

3.1.4 All above shooting times are valid for pit operated competitions or target carriers.

3.1.5 When electronic target systems are used the shooting times in World Championships, Regional Championships, World Cups or Paralympic Games are as follows:

Event	Discipline	Gender	Class	Shots	Time
R3	10m Air rifle prone	Mixed	SH1	60	1:15
R5	10m Air rifle prone	Mixed	SH2	60	1:15
R6	50m Rifle prone	Mixed	SH1	60	1:15
R7	50m Rifle prone	Men	SH1	40 prone 40 standing 40 kneeling	0:45 1:15 1:00
R8	50m Sport Rifle 3x20	Women	SH1	20 prone 20 standing 20 kneeling	2:15
R9	50m Rifle prone	Mixed	SH2	60	1:15

3.1.6 It is recommended that in 50m Sport Rifle 3x20 competitions, at least every third firing point is left empty to ensure position changes without disturbing other shooters during the round.

3.2 Tie breaking

3.2.1 Tie cases in the qualification round for more than 8 shooters will be handled as per the ISSF rules.

CHAPTER 4

4 PISTOL RULES

4.1 Pistol Events and shooting times

4.1.1 World Championships, Regional Championships and World Cups will comprise out of the following pistol events:

Event	Discipline	Gender	Class	Shots	Meter	Time
P1	10m Air pistol	Men	SH1	60	10	1:45
P2	10m Air pistol	Women	SH1	40	10	1:15
P3	25m Sport Pistol	Mixed	SH1	60	25	
P4	50m Free Pistol	Mixed	SH1	60	50	2:00
P5	10m Air pistol Standard	Mixed	SH1	40	10	

4.1.2 All shooting times are according to ISSF and IPC rules.

4.1.3 The event P5 is shot according to the ISSF rules on one stationary air pistol target. No final is shot in this event.

4.1.4 Trigger weight for P3 event will be 1000gr.

4.1.5 Trigger weight for P5 event will be 500gr.

4.2 Loading device (safety)

4.2.1 A device to hold the pistol to enable it to be loaded safely by hand/arm amputee may be used upon range official's approval.

4.3 Shooting position

4.3.1 In pistol shooting, the non-shooting arm/hand must not be on the shooting chair.

4.3.2 In all pistol events the armrests and sideboards of the shooting chair must be removed.

4.3.3 If the construction of the wheelchair requires a sideboard, the height of this may not exceed the height of the top of the wheel.

CHAPTER 5

5 SHOOTING FOR VISUALLY IMPAIRED ATHLETES

This section is completed at a later stage

CHAPTER 6

6 FALLING TARGETS RULES

6.1 Competition Format

- 6.1.1 The competition is run as a pool competition. Each pool consists out of 4 shooters that will compete against each other. The 2 best results go to the following round.
- 6.1.2 The composition of the different pools is based upon the ranking lists in the events R1, R4 and P1 of the month prior to the competition. The first ranked athlete will start in pool 1; the second ranked athlete in the last pool. The third athlete starts in pool 2. All the other start places are assigned according the same system.
- 6.1.3 The competition is shot as a separate event for Rifle SH1, Rifle SH2 and Pistol SH1.
- 6.1.4 In rifle the competition is shot in the standing position.
- 6.1.5 The weapon is a standard air rifle or pistol.
- 6.1.6 The targets are biathlon-type targets with 5 sights and the number of firing points to run the competition is 4.
- 6.1.7 Every phase of the pool is shot over 2 rounds of 5 shots with a time limit of 2 minutes 30 seconds.
- 6.1.8 The size of the inserts is as follows: (from left to right)
- Air Rifle: 6mm – 6mm – 5mm – 5 mm – 4 mm
 - Air Pistol: 24 mm – 24 mm – 16 mm – 16 mm – 11 mm

6.2 Competition Commands

- 6.2.1 Preparation Time
Shooters must have 5 minutes before the competition starts their final preparation including sighting shots including in the final. When all shooter have shot their first round the preparation time for the second round will be 3 minutes.
- 6.2.2 The commands for the competition are as follows:
YOU HAVE NOW 5 (3) MINUTES PREPARATION TIME – SIGHTING SHOTS INCLUDED.
THE END OF THE PREPARATION WILL BE ANNOUNCED 30 SECONDS BEFORE.
YOU SHOOT 2 SERIES OF 5 COMPETITION SHOTS.

THE TIME FOR EACH SERIES OF 5 SHOTS IS 2 MINUTES AND 30 SECONDS.

THE LOADING TIME BEFORE THE START OF THE SERIES IS 10 SECONDS AND THE SERIE STARTS WITH THE COMMAND "ATTENTION"

THE SHOOTING TIME IS STOPPED AFTER THE FULL COMPETITION TIME.

PREPARATION TIME STARTS NOW. (5 MINUTES)

30 seconds (is announced before the command 'Stop')

STOP

CHANGE TARGETS AND PUT OUT 5 PELLETS

*FOR THE FIRST COMPETITION SERIES LOAD
ATTENTION - START (2MINUTES 30 SECONDS)
STOP*

RESULTS

CHANGE TARGETS AND PUT OUT 5 PELLETS

FOR THE SECOND COMPETITION SERIE LOAD.....

- 6.2.3 After each series of 5 shots the fallen targets of each group must be counted, announced to the shooter and recorded in the score card.
- 6.2.4 If a shooter fails to shoot within the allowed time limit, the shot(s) is counted as zero.
- 6.2.5 In case of equality a shoot-off on the extreme right target will determine the winner.
In case of an SH1 rifle or pistol shooters: after 3 attempts without decision times the shoot-off proceed on the 4th target (5mm/16mm) until decision.
For SH2 shooters the shoot-off is on the extreme right target.
The time for the shoot-off is 30 seconds
- 6.2.6 For the competition matrix see Appendix 3.

CHAPTER 7

7 TEAM COMPETITION

7.1 Team Competition

- 7.1.1 There will be team competitions in each event (except Falling Targets) as numbers permit except for the Paralympic Games (as per I.S.S.F.).
- 7.1.2 All teams must consist of three (3) competitors.
- 7.1.3 In competitions up to level 2, two teams per country are allowed in each event.
- 7.1.4 In level 3 competitions, only one team per country is allowed in each event.
- 7.1.5 To have team-competition in an event, at least four countries must be on the start list of that event.
- 7.1.6 Team scores will be shot concurrently with the individual scores, i.e. no separate team matches will be shot.
- 7.1.7 Medals will be presented in team events as per regulations of ISSF and/or IPC (3 gold, 3 silver and 3 bronze medals).

CHAPTER 8

8 REGULATIONS

8.1 Competition Management

- 8.1.1 IPC Shooting alone shall have the right to manage World Championships and sanctioned competitions. The words World and IPC Shooting may not be used in connection with any shooting event without the consent of IPC Shooting.
- 8.1.2 IPC Shooting is empowered to formulate all rules and regulations for the conduct of such competitions. All regulations set by IPC Shooting must be announced and published six months prior to the opening day of the competition.
- 8.1.3 IPC Shooting shall have jurisdiction over all matters not assigned by the rules to the referees, or other officials and shall have power to postpone events and give directions consistent with rules adopted for conducting any event.
- 8.1.4 In World Championships an event is viable if in the start list are a minimum of four (4) participating countries and a minimum of eight (8) eligible shooters.
- 8.1.5 The competitions can be split into Air and firearms competitions.
- 8.1.6 For separate Air competitions the following events must be included in every Championships:
- 8.1.7 Rifle: R1-R2-R3-R4-R5-FTR1-FTR2
Pistol: P1-P2-P5-FTP
- 8.1.8 For World and Regional Championships and World Cups IPC Shooting may allow Organizing Committees to limit the number of competitors per country per event.

8.2 Officials

8.2.1 At IPC competitions IPC Shooting shall appoint the Technical Delegate, and shall appoint or approve the following minimum number of ten (10) officials to run the competition. The same ten (10) referees are used to cover all below Juries with the exception of the Jury of Appeal which consists of the TD, the Chief Referee and one (1) ISSF referee appointed by IPC Shooting and is announced prior to the start of the competition:

Jury of Appeal (3)

Rifle Jury (3)

Pistol Jury (3)

Classification Jury (3)

Equipment Jury (3)

Chief Classifier (1) and Classifiers (appropriate number) if applicable

8.2.2 At sanctioned competitions IPC Shooting shall appoint the following minimum number of officials: Chief Referee, 1- 2 referees (based on the event programme), and classifiers if applicable.

8.2.3 The composition of the Jury for each sanctioned competition shall be:

1 ISSF referee according to ISSF rules

2 IPC Shooting appointed referees, 1 for pistol and 1 for rifle

IPC Shooting referees must hold an ISSF B-license.

8.2.4 For approved competitions IPC Shooting appoints 2- 3 IPC Shooting referees (based on the event programme), and classifiers if applicable and the LOC shall appoint an appropriate number of officials.

8.2.5 For IPC competition, and sanctioned competitions a Local Organizing Committee (LOC) shall be appointed by the responsible body to manage the competition.

8.2.6 The LOC, in conjunction with the IPC Shooting shall be responsible for the entire management of the contest, including the arrangement of the programme of events, arrangement for the classification of shooters, all technical equipment and installation prior to and during competition.

8.2.7 Technical Delegate (TD)

- 8.2.7.1 The Technical Delegate shall be responsible to conduct site visits during the preparation period of the competition, check the Field Of Play (FoP) and ensure that the competition will run smoothly and according to the rules and regulations.
- 8.2.7.2 The Technical Delegate shall be responsible for the competition Field Of Play (FoP) and ensure that the competition is run smoothly and according to the rules and regulations.
- 8.2.7.3 The Technical Delegate is ultimately responsible for all technical matters of the competition.
- 8.2.7.4 The Technical Delegate is ultimately responsible for all IPC Shooting officials appointed.
- 8.2.7.5 The random allocation of shooters to firing points and relays may be done either by the drawing of the lots or with a computer programme suited to this purpose, under the supervision of the Technical Delegate.
- 8.2.7.6 When electronic scoring targets are used, targets must be checked for functioning and accuracy under the supervision of the Technical Delegate.
- 8.2.7.7 A report on newly established World or Paralympic records must be prepared by the IPC Shooting Technical Delegate at the end of the Championships.

8.2.8 Duties and functions of IPC Shooting Chief Classifier and Classifiers

The duties and functions of the IPC Shooting Chief Classifier and Classifiers are described in the IPC Shooting Classification manual.

8.3 Minimum Qualifying Standards (MQS)

- 8.3.1 The Minimum Qualifying Standards will be defined by IPC Shooting for major competitions and published in the Qualification Documentation. (see Appendix 4)
- 8.3.2 All shooters are required to reach the MQS set to be eligible to compete, with the exception if a wild card entry is offered.

8.3.3 Qualifying scores will be verified by IPC Shooting and can be achieved at IPC Shooting recognized competitions only.

8.4 Competitions and Qualifications

8.4.1 IPC Competitions (Paralympic Games, World Championships, Regional Championships)

8.4.1.1 The entry criteria (number of athletes/NPC, MQS, list of events, etc.) shall be defined in the Qualification Documentation.

8.4.2 Regional Championships

8.4.2.1 Regional Championships can also be organized as Open Regional Championships based on the viability of the events and following IPC Shooting approval.

8.4.2.2 In case of Open Regional Championships there will be shot only one (1) final in each event with 8 finalists from the Open result list.

8.4.3 World Cups

8.4.3.1 There are no Minimum Qualification Standard (MQS) requirements for World Cups.

8.4.4 Approved competitions

8.4.4.1 There are no Minimum Qualification Standard (MQS) requirements for Approved competitions.

8.5 Process for Approved Competitions

8.5.1 All applications for IPC Shooting International competition approval must be completed in full and submitted to IPC Shooting **no later than the 1st of October** of the year preceding the competition.

8.5.2 The competition must be staffed by IPC Shooting National and International Technical Officials. The official panel(s) of referees will be appointed by IPC Shooting.

8.5.3 For detailed process and minimum requirements see Appendix 5

8.6 Process for Sanctioned Competitions

8.6.1 World Cups

8.6.1.1 All applications for IPC Shooting International competition approval must be completed in full and submitted to IPC Shooting **no later than the 1st of September** of the year preceding the competition.

8.6.2

8.6.2.1 For detailed process and minimum requirements see Appendix 6

8.6.3

8.6.3.1 The World Cup programme can be as follows:

Programme 1	R1-R8 / P1-P4 / FT
Programme 2	R1-R5 / P1-P2 / (FT)
Programme 3	R6 - R8 / P3 - P4

8.6.3.2 The shooting programme will determine the minimum number of IPC Shooting Referees who must be present during the competition. The numbers per World Cup programme will be as follows:

World Cup	Number of IPC Shooting Referees
Programme 1	3
Programme 2	2
Programme 3	2

8.6.3.3 . A minimum of 4 countries is needed to participate in every event at the competition to have a valid qualification event. The organizer needs to notify IPC Shooting in case this criterion will be in danger. If this criterion is not fulfilled, the participating countries need to be notified immediately after the deadline of entries and may be offered the event without qualification status.

8.7 Results

8.7.1 Scoring procedures for all IPC Shooting events are followed as those are described in the ISSF rulebook.

8.7.2 The result book must be submitted within 14 days of the end of Competition (signed off results and electronic version in excel format). In the results list must be included the ID and license numbers of the athletes.

8.8 Rankings

- 8.8.1 IPC Shooting shall maintain world and regional rankings based on the results submitted by the LOCs from IPC Shooting recognized competitions.
- 8.8.2 A ranking system will determine the best performing athlete per event based on a point system.
- 8.8.3 Only athletes that are licensed, have a sport class status Review or Confirmed and reach the rankings cut-off standard for the relevant event will have their results recognized for ranking purposes.
- 8.8.4 The cut-off standard in order for an athlete to be introduced in the ranking lists is the Minimum Qualification Standard (MQS) for World Championships.
- 8.8.5 Ranking points will be attributed depending on the level of competition and according to the following table:

Level 1: International Approved Competitions

Level 2: World Cup Competitions

Level 3: World and Regional Championships

Rank	Level 3	Level 2	Level 1
1	50	30	15
2	45	25	13
3	41	22	11
4	37	19	9
5	34	17	7
6	31	15	5
7	28	13	4
8	25	11	3
9	21	9	2
10	18	7	1
11	15	6	
12	12	5	
13	10	4	
14	8	3	
15	6	2	

8.8.6 Competitions of Level 2 and higher are automatically placed in the ranking system.

8.8.7 Level 1 competitions need to apply for recognition in the system. To be a recognized competition at least 3 countries need to be at the start list of each event.

8.8.8 Organizers need to use the electronic result sheets (excel format) supplied by IPC Shooting

8.9 World and Regional Records

8.9.1 IPC Shooting will ratify World or Regional records which fulfill the below criteria:

- a. be Paralympic Games, World or Regional championships.
- b. be sanctioned by IPC Shooting.
- c. be shot in accordance with the I.S.S.F. and IPC Shooting rules.
- d. all records are subject to doping control.

8.9.2 For sanctioning and record acknowledgement purpose, the Organizing Committee of a competition have to comply with the following conditions:

- a. IPC Shooting office shall be notified of competition details according to IPC Shooting rules.
- b. one (1) IPC Shooting Technical Delegate or a technical representative must attend the competition, at the expense of the organizing committee, to supervise the competition.
- c. two (2) IPC Shooting referees must attend the competition as jury members at the expense of the organizing committee.
- d. two (2) IPC Shooting classifiers must attend the classification at the expense of the organizing committee,
- e. all results and records achieved shall be forwarded to IPC Shooting office, for registration and maintenance of the records-book within two months after the competition.
- f. the form "Application for Shooting-record" (must be submitted in time to the IPC Shooting office).

CHAPTER 9

9 EDUCATION

9.1 IPC Shooting Technical Officials

9.1.1 IPC Shooting has developed specific pathway for the education and certification of the Technical Officials.

9.1.2 Only IPC Shooting can certify IPC Shooting Technical Officials on the various levels.

9.1.3 The minimum qualification in order to become an IPC Shooting Technical Official is to hold a valid ISSF Judges “B” License.

9.2 IPC Shooting Technical Officials Levels

9.2.1 The minimum qualification in order to become an IPC Shooting Technical Official is to hold a valid ISSF Judges “B” License.

Junior International Referee

The successful completion of two (2) days referee workshop including the examination is required.

Following the successful completion a certificate will be sent by IPC Shooting. Certified Junior International Referees may be allowed to attend an International approved competition accompanied by Senior International Referees.

Senior International Referee

Certified Junior International referees can be upgraded to Senior International Referees by working under supervision for two (2) officiate sanctioned shooting competitions under the supervision of an IPC Shooting Supervising Referee at their own expense.

The IPC Shooting Supervising Referee will submit to IPC Shooting the Evaluation of Performance / Progress Report of Approval after the sanctioned competitions.

The IPC Shooting officials who supervised the officiating work that the Junior International Referee did over the two (2) IPC Shooting competitions submit a letter of assessment to IPC Shooting.

Senior International Referees are competent to run World Cups.

Supervising Referee

The basis for upgrading to the status IPC Shooting Supervisor Referee is the experience over a number of years acquired as Senior International Referee

- He/she must be an active Senior International Referee for at least four (4) years
- He/she must have the ISSF EST-License (Electronic-Scoring-Target-License)
- Must have attended at least on five (5) competitions level 3 or higher.

On at least two occasions the applicant must have been a Jury Member. The other three occasions must have been as a Chief Range Officer, Chief Referee, Chief of Classification or Chief of Equipment Control.

IPC Shooting will decide on the upgrading applications at its annual meeting.

After the upgrade of the International IPC Shooting - License to IPC Shooting Supervisor Referee License he/she is responsible to write a report when working as Supervisor for every applicant which works under Supervision to the IPC Shooting Head of Officiating.

The referee allocation to competition will be based on the level of competency in relation to the weight of the competition.

CHAPTER 10

10 PRIOR COMPETITION PROCESSES

10.1 Equipment Control

10.1.1 Before the start of the competition, every athlete will have his equipment checked by the international Equipment control panel and have his equipment control card filled in.

10.2 International Classification

10.2.1 International Classification will be executed prior to the start of the competition.

10.2.2 The Chief Classifier of the competition will draft a list and timetable for athletes to present themselves for classification.

10.3 Technical Meeting

10.3.1 Before the start of the competition there must be a technical meeting with representatives of the participating countries and the Organizing Committee, supervised by the IPC Shooting Technical Delegate or Chief Referee.

10.3.2 Before the start of the technical meeting the classification processes must have been completed.

APPENDIXES SECTION

APPENDIX 1

(Start Number)

_____ 280mm _____

COMPETITION / CHAMPIONSHIPS NAME

START NUMBERAthlete's Family Name & Initial of given
Name

SPORT CLASS & subclass

COUNTRY CODE230
mm

APPENDIX 2



IPC SHOOTING

Firearms & Equipment Control :

Shooter's Family Name	Given Name	Gender	Sport Class	Country	IPC Shooting-ID No.	Start No.
		Male / Female	SH			

(✓) tick your participating Event

Rifle				
W	Event	Discipline	Gender	Class
	R1	Air rifle standing	Men	SH1
	R2	Air rifle standing	Women	SH1
	R3	Air rifle prone	Mixed	SH1
	R4	Air rifle standing	Mixed	SH2
	R5	Air rifle prone	Mixed	SH2
	R6	English Match .22	Mixed	SH1
	R7	Free Rifle .22	Men	SH1
	R8	Spot Rifle .22	Women	SH1
	R9	English Match .22	Mixed	SH2
	R10	Air rifle standing	Mixed	SH3
	R11	Air rifle prone	Mixed	SH3
	PTR1	Falling targets	Mixed	SH1
	PTR2	Falling targets	Mixed	SH2

Pistols				
W	Event	Discipline	Gender	Class
	P1	Air pistol	Men	SH1
	P2	Air pistol	Women	SH1
	P3	Spot Pistol .22	Mixed	SH1
	P4	Free Pistol .22	Mixed	SH1
	P5	Air Pistol Standard	Mixed	SH1
	PTP	Falling Targets	Mixed	SH1

Shooter's Signature / Date

Shooter's Firearms :

Type	Manufacturer / Model	Serial No.
Rifle / Pistol		
Rifle / Pistol		
Rifle / Pistol		
Rifle / Pistol		

ISSF

Firearms & Equipment Control (Rifles)

Standards for all Rifles	Check / Sign
Clothing / Shooting gears including Blinder on rear sight	

ISSF

Firearms & Equipment Control (Pistols)

Standards for all Pistols	Check / Sign
Clothing / Shooting gears including Side Blinders	

Remarks :

IPC Shooting Examiner's Signature / Date

IPC Shooting Firearms & Equipment Control

Equipment :	Check / Sign
Firearms	
Jacket	
Trousers	
Shoes / Orthopaedic boots	
Kneeling roll	
Straps to chair / legs	
Tables :	Check / Sign
From Table	
Horizontality	
Size	
Compressive material	
Kneeling Table	Check / Sign
Horizontality	
Size	
Compressive material	
10cm diameter block	
Chairs :	Check / Sign
Armrests	
Side posts	
Low backrest	
High backrest	
Stretch backrest	
Normal / High chairs	
Support Stand :	Check / Sign
Rifle-holder	
Spring measuring	
Prosthesis rifle support	
Balance mark on rifle	
Pistols :	Check / Sign
Holder for pistols	

APPENDIX 3

FALLING TARGETS COMPETITION FORMAT

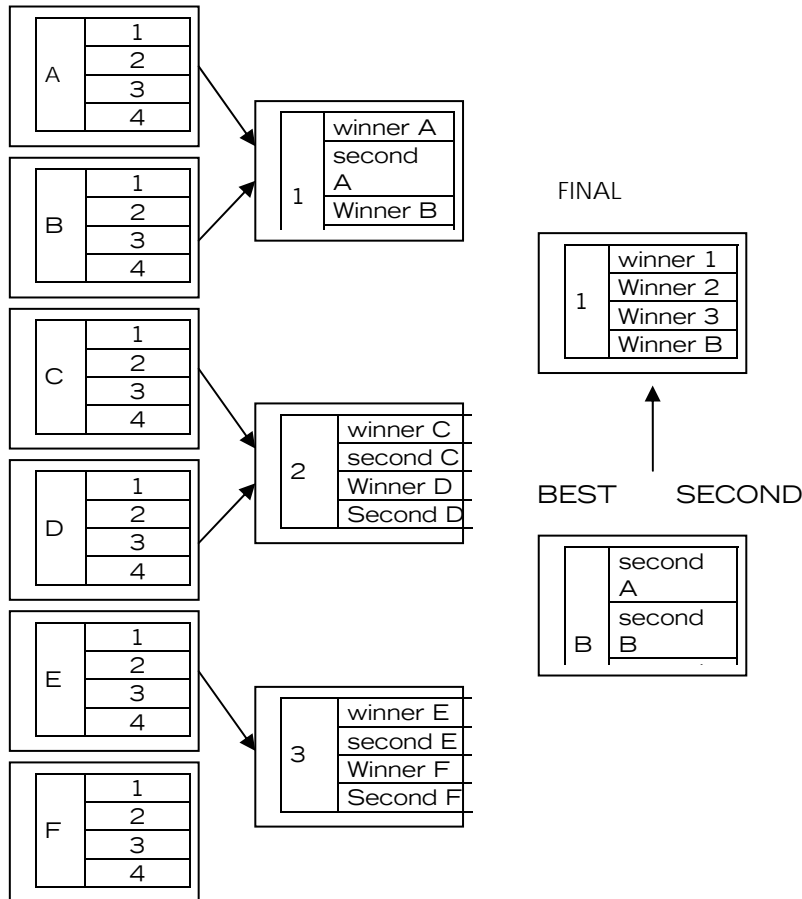

APPENDIX 4

10.3.3 The London 2012 Paralympic Games Minimum Qualification Standards are available on the IPC website under:
http://www.paralympic.org/Paralympic_Games/London_2012/Qualification_Criteria/index.html

10.3.4 The Minimum Qualification Standards for World and Regional Championships are as follows:

Event	Discipline	Gender	Class	Qualification
R1	10m Air rifle standing	Men	SH1	545
R2	10m Air rifle standing	Women	SH1	355
R3	10m Air rifle prone	Mixed	SH1	575
R4	10m Air rifle standing	Mixed	SH2	570
R5	10m Air rifle prone	Mixed	SH2	575
R6	50m Rifle prone	Mixed	SH1	560
R7	50m Free Rifle 3x40	Men	SH1	1060
R8	50m Sport Rifle 3x20	Women	SH1	525
R9	50m Rifle prone	Mixed	SH2	560
FTR1	10m Falling Targets	Mixed	SH1	-
FTR2	10m Falling Targets	Mixed	SH2	-

Event	Discipline	Gender	Class	Qualification
P1	10m Air pistol	Men	SH1	535
P2	10m Air pistol	Women	SH1	340
P3	25m Sport Pistol	Mixed	SH1	530
P4	50m Free Pistol	Mixed	SH1	490
P5	10m Air Pistol Standard	Mixed	SH1	-
FTP	10m Falling Targets	Mixed	SH1	-

APPENDIX 5

(Approved competitions)

The most updated processes and minimum requirements for IPC Shooting Approved competitions are available on the IPC Shooting website on the downloads and forms section.

APPENDIX 6

(World Cups)

The most updated processes and minimum requirements for IPC Shooting World Cups competitions are available on the IPC Shooting website on the downloads and forms section.